

Scenario 1, 6 Wire No Electric Heat
2C, 2H

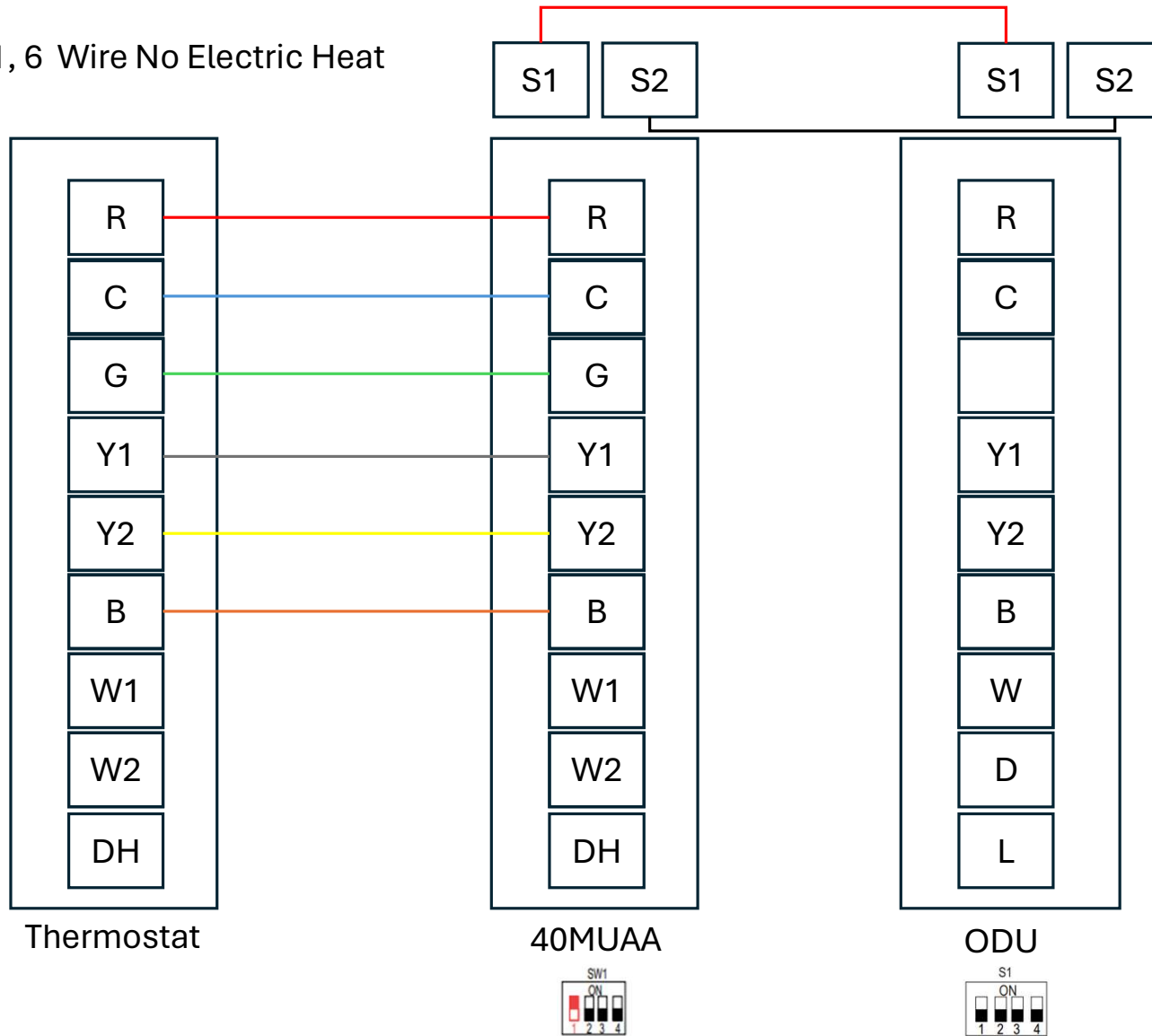

** Reversing Valve energize in Heat**

Doted Line is optional