

Scenario 3, 6 Wire No Electric Heat
2C, 2H

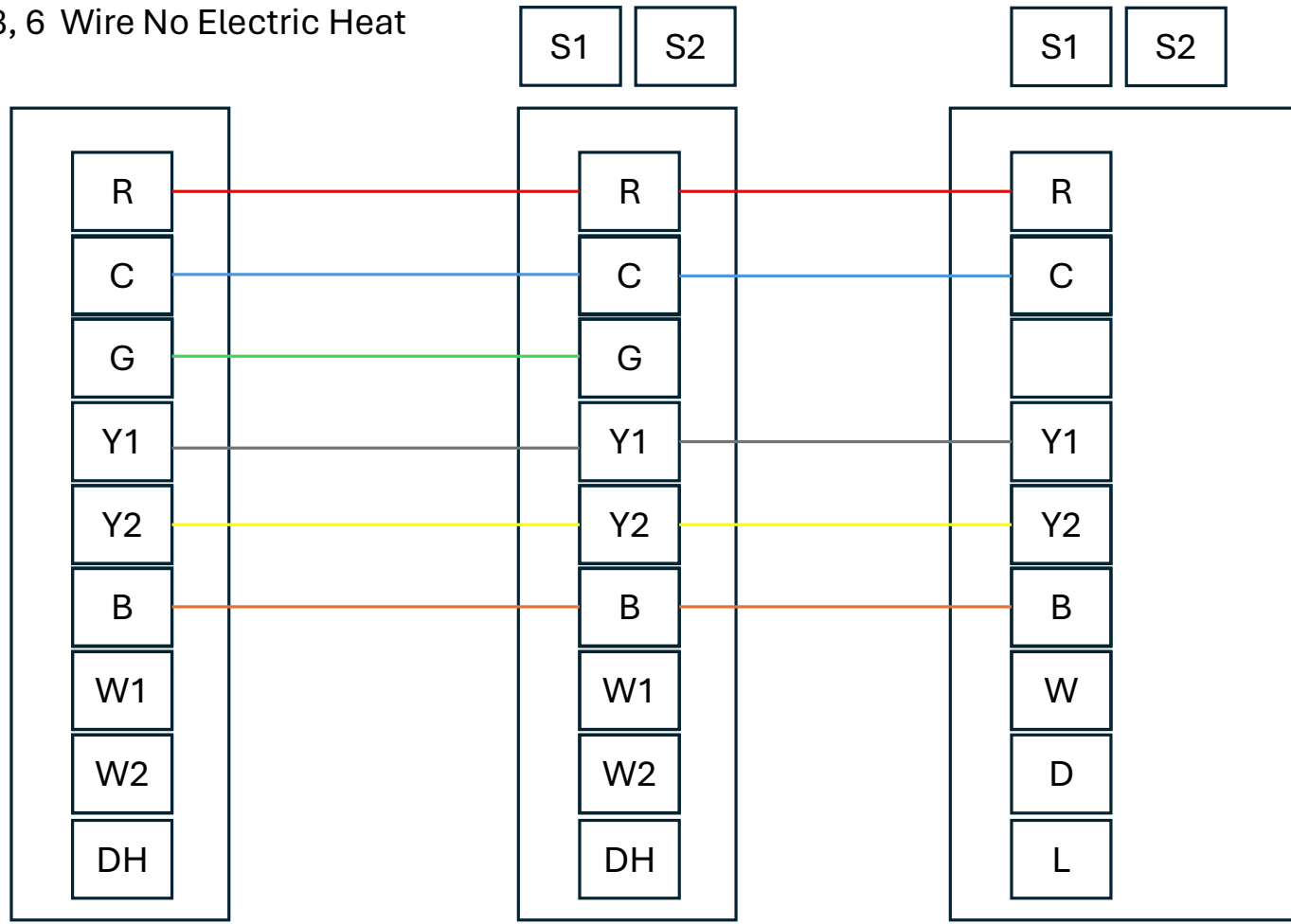

Thermostat

40MUAA

ODU



** Reversing Valve energize in Heat**

Doted Line is optional